

# **GLEASON PowerFlex**



**Enclosed conduit  
cable and hose carrier  
for machine tools,  
robots and material  
handling equipment.**

**Modular design  
allows shortening  
or lengthening  
PowerFlex, replacing  
damaged sections or  
altering mounting brackets,  
all on site. Polished stainless  
steel outer shell and smooth,  
self-lubricating fiber-reinforced Nylon  
inner liner provides ultimate protection to  
cables and hoses and promotes long conduit life,  
even in harsh environments.**

# How to Order:

- Determine size of PowerFlex carrier needed to accommodate total number of cables and/or hoses required for application. Sum of cross sectional areas of all cables and hoses must not exceed 60% of window area (E on Model Chart below).
- Compute overall PowerFlex length based on following formula (see drawing at right):  

$$\frac{1}{2} \text{ TOTAL MACHINE TRAVEL} + L$$
 "L" equals curve length (chart below).
- Select type of mounting flange for each end from tables below.
- Develop part number:

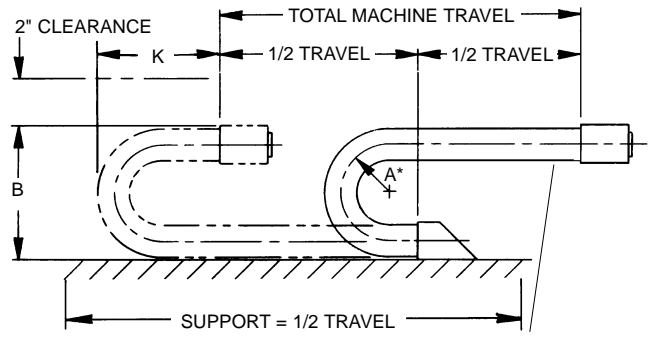

PowerFlex LENGTH equals  
 $\frac{1}{2}$  Total Machine Travel + L

**EXAMPLE**      2040-5.5 - 7 - SM-A / SF - 1

MODEL NO. \_\_\_\_\_  
 OVERALL LENGTH (feet\*) \_\_\_\_\_  
 MOVABLE END BRACKET \_\_\_\_\_  
 CONFIGURATION (see drawings, right) \_\_\_\_\_  
 FIXED END BRACKET \_\_\_\_\_  
 APPLICATION ARRANGEMENT (see drawings, right) \_\_\_\_\_

\*Round length to nearest 1/2 foot.

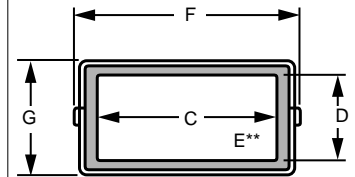
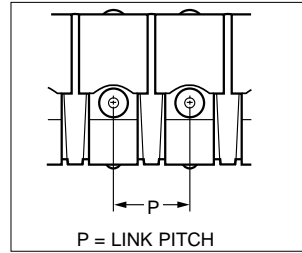

## MODEL CHART

DIMENSIONS IN INCHES UNLESS OTHERWISE INDICATED (See drawings above)

MODEL NO.	A*	B	C	D	E**	F	G	K	MAX. CABLE/HOSE DIAMETER (in.)	WT./ FT.	P	CURVE LENGTH L (ft.)	SELF-SUPPORTING LENGTH***
917-2.5	2.56	6.61	1.77	0.98	1.73	2.44	1.50	7.24	0.79	0.85	0.79	1.5	2.5' @ 2 lb/ft.
917-3.9	3.94	9.37	1.77	0.98	1.73	2.44	1.50	8.62	0.79	0.85	0.79	2.0	2.5' @ 2 lb/ft.
917-5.9	5.91	13.31	1.77	0.98	1.73	2.44	1.50	10.59	0.79	0.85	0.79	2.5	2.5' @ 2 lb/ft.
1514-3.9	3.94	9.92	1.41	1.57	2.21	2.36	2.05	8.90	1.26	1.10	0.79	2.0	2.5' @ 3.2 lb/ft.
1528-3.9	3.94	9.92	2.87	1.50	4.31	3.62	2.05	8.90	1.30	1.30	0.79	2.0	3.0' @ 3.8 lb/ft.
1528-5.9	5.91	13.86	2.87	1.50	4.31	3.62	2.05	10.87	1.30	1.30	0.79	2.5	3.0' @ 3.8 lb/ft.
1528-7.8	7.87	17.80	2.87	1.50	4.31	3.62	2.05	12.84	1.30	1.30	0.79	3.0	3.0' @ 3.8 lb/ft.
1528-9.8	9.84	21.73	2.87	1.50	4.31	3.62	2.05	14.80	1.30	1.30	0.79	3.5	3.0' @ 3.8 lb/ft.
2040-5.5	5.51	13.66	4.01	2.05	8.22	4.84	2.64	11.77	1.69	1.78	0.98	2.5	3.5' @ 6.7 lb/ft.
2040-8.8	8.86	20.35	4.01	2.05	8.22	4.84	2.64	15.12	1.69	1.78	0.98	3.5	3.5' @ 6.7 lb/ft.
2040-11.8	11.81	26.26	4.01	2.05	8.22	4.84	2.64	18.07	1.69	1.78	0.98	4.0	3.5' @ 6.7 lb/ft.
2739-6.1	6.10	18.59	3.98	2.76	10.98	5.00	3.39	12.72	2.28	1.10	0.98	2.5	3.5' @ 8.9 lb/ft.
2739-7.8	7.87	19.13	3.98	2.76	10.98	5.00	3.39	14.49	2.28	1.10	0.98	3.0	3.5' @ 8.9 lb/ft.
2863-7.2	7.28	18.27	6.38	2.83	18.02	7.48	3.70	15.04	2.36	3.56	1.18	3.0	4.5' @ 13.4 lb/ft.
2863-9.8	9.84	23.39	6.38	2.83	18.02	7.48	3.70	17.60	2.36	3.56	1.18	3.5	4.5' @ 13.4 lb/ft.
2863-13.7	13.78	31.26	6.38	2.83	18.02	7.48	3.70	21.54	2.36	3.56	1.18	4.5	4.5' @ 13.4 lb/ft.

\* Bending Radius Minimum Dimension. \*\*Area of window in square inches. Formula: C x D = E

\*\*\*If application exceeds self-supporting length, please consult factory. Support stands are available to increase travel length.

### SCOOP MOUNT (SM)

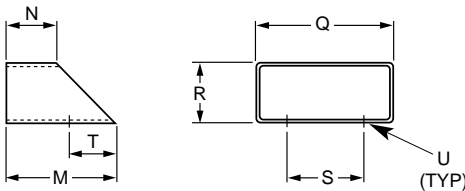

MODEL NO.	M	N	Q	R	S	T	U
917-2.5	1.73	0.79	2.17	1.42	0.87	0.49	0.26
917-3.9	1.73	0.79	2.17	1.42	0.87	0.49	0.26
917-5.9	1.73	0.79	2.17	1.42	0.87	0.49	0.26
1514-3.9	1.73	0.79	2.17	2.04	0.87	0.49	0.26
1528-3.9	2.76	1.26	3.35	1.97	1.97	0.59	0.26
1528-5.9	2.76	1.26	3.35	1.97	1.97	0.59	0.26
1528-7.8	2.76	1.26	3.35	1.97	1.97	0.59	0.26
1528-9.8	2.76	1.26	3.35	1.97	1.97	0.59	0.26
2040-5.5	3.31	1.34	4.61	2.60	2.76	0.69	0.33
2040-8.8	3.31	1.34	4.61	2.60	2.76	0.69	0.33
2040-11.8	3.31	1.34	4.61	2.60	2.76	0.69	0.33
2739-6.1	3.23	1.89	4.72	3.31	2.76	0.69	0.33
2739-7.8	3.23	1.89	4.72	3.31	2.76	0.69	0.33
2863-7.2	3.94	1.77	7.17	3.62	3.94	0.86	0.41
2863-9.8	3.94	1.77	7.17	3.62	3.94	0.86	0.41
2863-13.7	3.94	1.77	7.17	3.62	3.94	0.86	0.41

### SQUARE MOUNT (SQ)

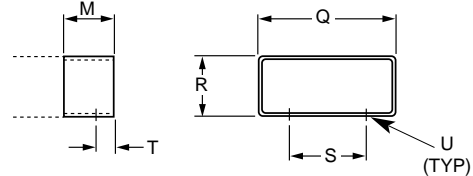

MODEL NO.	M	Q	R	S	T	U
917-2.5	0.79	2.17	1.42	0.86	0.33	0.26
917-3.9	0.79	2.17	1.42	0.86	0.33	0.26
917-5.9	0.79	2.17	1.42	0.86	0.33	0.26
1514-3.9						
1528-3.9	0.98	3.35	2.05	1.97	0.39	0.26
1528-5.9	0.98	3.35	2.05	1.97	0.39	0.26
1528-7.8	0.98	3.35	2.05	1.97	0.39	0.26
1528-9.8	0.98	3.35	2.05	1.97	0.39	0.26
2040-5.5	1.38	4.57	2.68	2.56	0.39	0.33
2040-8.8	1.38	4.57	2.68	2.56	0.39	0.33
2040-11.8	1.38	4.57	2.68	2.56	0.39	0.33
2739-6.1	1.38	4.72	3.31	2.76	0.49	0.33
2739-7.8	1.38	4.72	3.31	2.76	0.49	0.33
2863-7.2	1.57	7.17	3.62	3.94	0.59	0.41
2863-9.8	1.57	7.17	3.62	3.94	0.59	0.41
2863-13.7	1.57	7.17	3.62	3.94	0.59	0.41

# APPLICATION ARRANGEMENTS

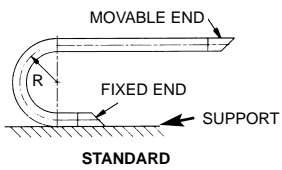

Most common arrangement. Fixed end is below and located at midpoint of machine travel and PowerFlex carrier is supported on bottom.

APPLICATION 1

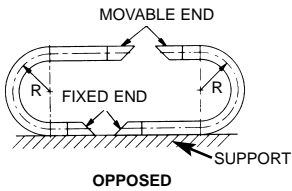

Two PowerFlex carriers operating opposed in respect to each other. NOTE: Both carriers must be same length.

APPLICATION 2

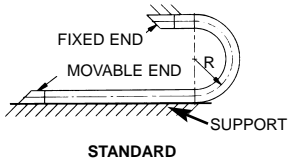

Opposite of arrangement (1) in that movable end is below fixed end. Support must be 1/2 length machine travel.

APPLICATION 3

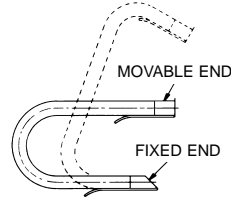

Combination of both vertical and horizontal motions. Supports are required to protect against sharp bends to PowerFlex.

APPLICATION 4

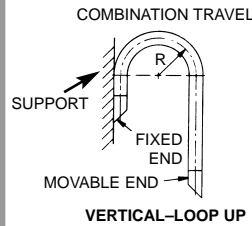

Vertical travel with loop up.

APPLICATION 5

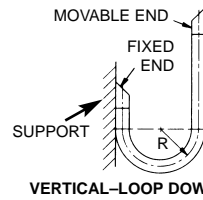

Vertical travel with loop down.

APPLICATION 6

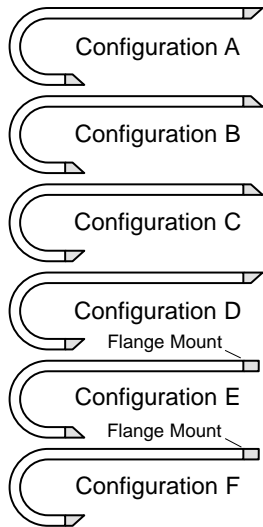

## MOUNTING CONFIGURATIONS

Mounting configuration must be included as part of model number if scoop or square mounting brackets are required on one or both ends (see "How to Order", left). Optional top/bottom flange and side flange styles, available on either end of PowerFlex, are symmetrical. Mounting bracket configuration may be field altered.

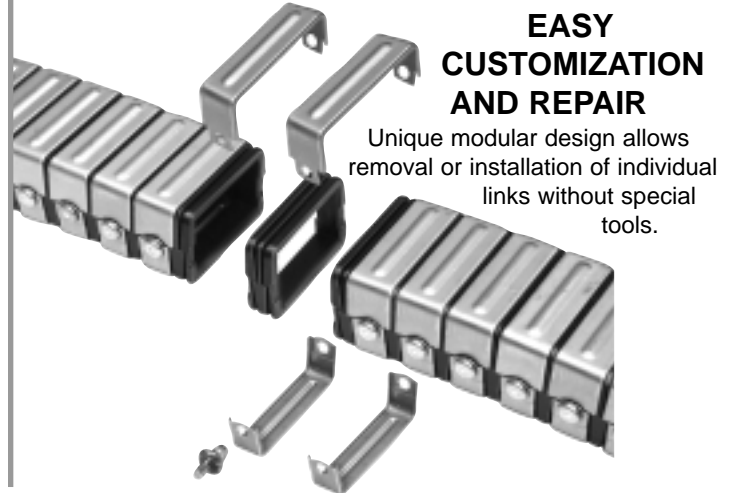

## EASY CUSTOMIZATION AND REPAIR

Unique modular design allows removal or installation of individual links without special tools.

### TOP & BOTTOM FLANGE (TF)

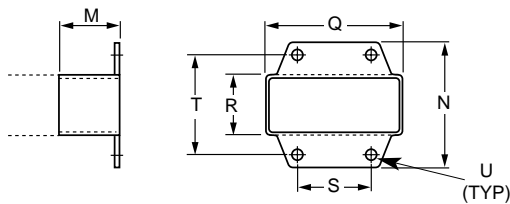

MODEL NO.	M	N	Q	R	S	T	U
917-2.5	0.79	2.76	2.17	1.38	0.71	2.17	0.26
917-3.9	0.79	2.76	2.17	1.38	0.71	2.17	0.26
917-5.9	0.79	2.76	2.17	1.38	0.71	2.17	0.26
1514-3.9							
1528-3.9	0.98	3.35	3.35	1.97	1.77	2.76	0.26
1528-5.9	0.98	3.35	3.35	1.97	1.77	2.76	0.26
1528-7.8	0.98	3.35	3.35	1.97	1.77	2.76	0.26
1528-9.8	0.98	3.35	3.35	1.97	1.77	2.76	0.26
2040-5.5	1.38	4.33	4.57	2.52	2.36	3.54	0.33
2040-8.8	1.38	4.33	4.57	2.52	2.36	3.54	0.33
2040-11.8	1.38	4.33	4.57	2.52	2.36	3.54	0.33
2739-6.1							
2739-7.8							
2863-7.2	1.57	5.35	7.17	3.54	3.74	4.33	0.41
2863-9.8	1.57	5.35	7.17	3.54	3.74	4.33	0.41
2863-13.7	1.57	5.35	7.17	3.54	3.74	4.33	0.41

### SIDE FLANGE (SF)

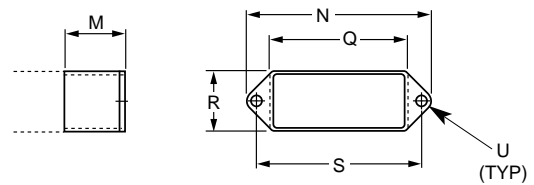

MODEL NO.	M	N	Q	R	S	U
917-2.5	0.79	3.54	2.17	1.38	2.95	0.26
917-3.9	0.79	3.54	2.17	1.38	2.95	0.26
917-5.9	0.79	3.54	2.17	1.38	2.95	0.26
1514-3.9						
1528-3.9	0.98	4.72	3.35	1.97	4.13	0.26
1528-5.9	0.98	4.72	3.35	1.97	4.13	0.26
1528-7.8	0.98	4.72	3.35	1.97	4.13	0.26
1528-9.8	0.98	4.72	3.35	1.97	4.13	0.26
2040-5.5	1.38	6.30	4.57	2.52	5.51	0.33
2040-8.8	1.38	6.30	4.57	2.52	5.51	0.33
2040-11.8	1.38	6.30	4.57	2.52	5.51	0.33
2739-6.1						
2739-7.8						
2863-7.2	1.57	8.90	7.17	3.54	7.87	0.41
2863-9.8	1.57	8.90	7.17	3.54	7.87	0.41
2863-13.7	1.57	8.90	7.17	3.54	7.87	0.41

# GLEASON PowerFlex

Protect and control cables and hoses to moving machines.

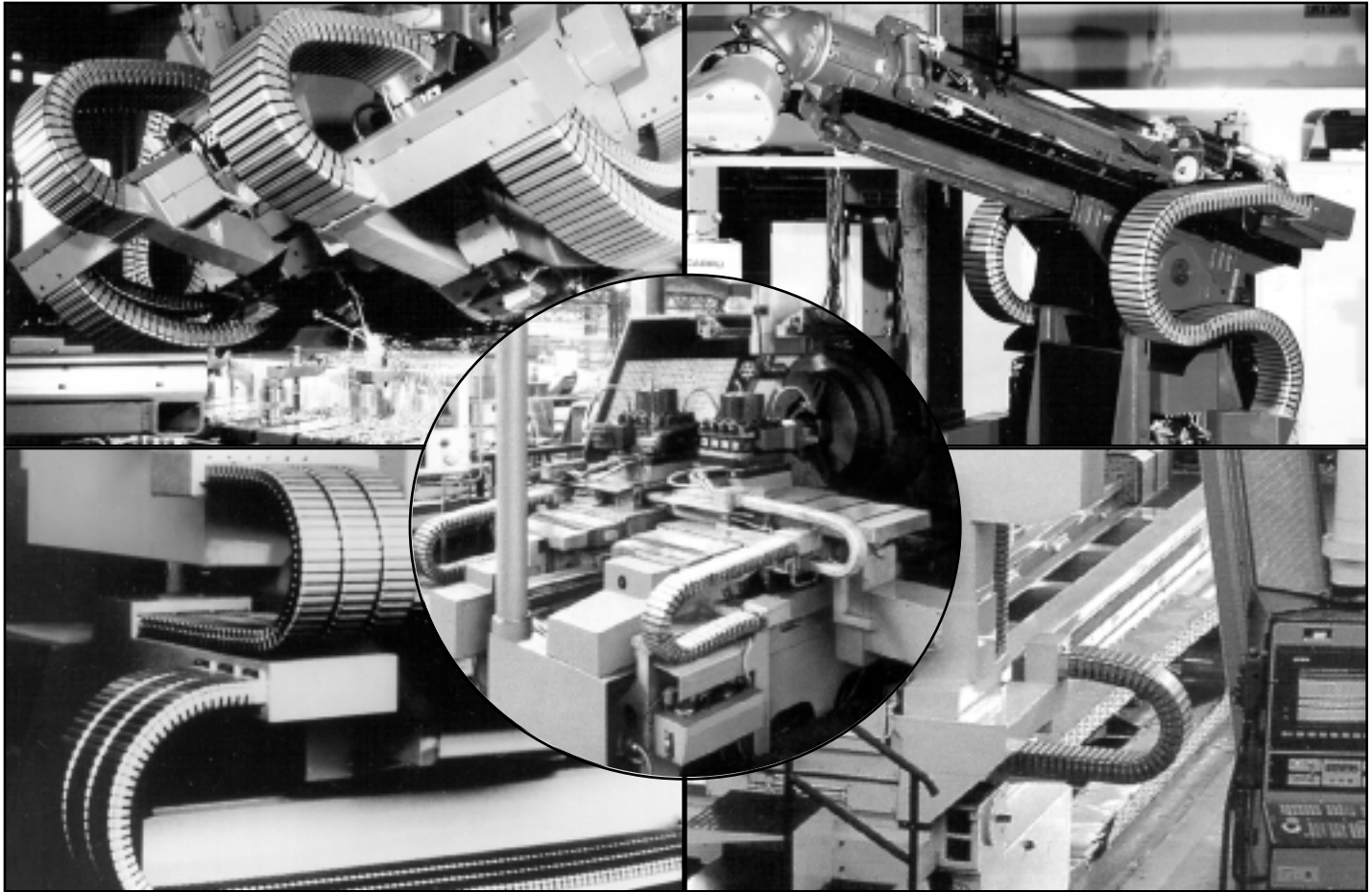

- Complete cable and hose protection from high temperatures and hot chips.
- Rugged stainless steel sections mechanically riveted for strength.
- Operates in temperatures to 250°.

- Self-lubricating fiber-reinforced Nylon inner liner provides ultimate protection to cables and hoses.
- Installs in any position.
- Wide range of sizes.
- Economical.



## Brake Products, Inc.

16751 Hilltop Park Place  
Chagrin Falls, OH 44023  
Phone: (888) 861-8777 • Fax: (440) 543-7963